

Finger Blanks for GS Grippers

(Dimensioned drawings shown full scale)

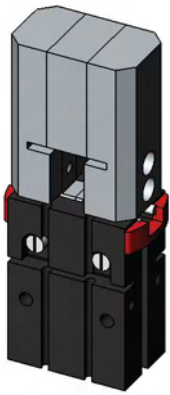

Gripper Fingers shown closed. (fingers overlap)
Cut away material to fit your part.

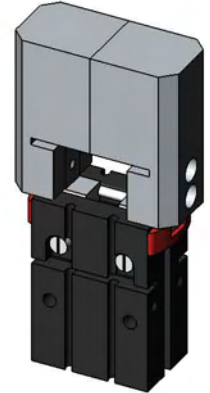
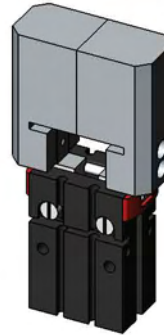
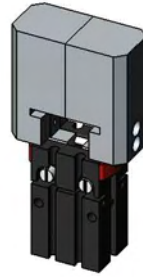
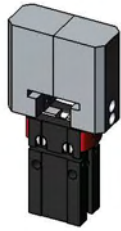

Gripper Fingers shown fully open.

Finger Blanks for GS Grippers

Quick#	Part#	Material	Wt. (g)	Price
5884	GS-10-FBA	Aluminum	68	\$19.30
5885	GS-10-FBP	Acetal	3.5	\$19.30
5886	GS-16-FBA	Aluminum	134	\$23.85
5887	GS-16-FBP	Acetal	7	\$23.85
5888	GS-20-FBA	Aluminum	210	\$27.20
5889	GS-20-FBP	Acetal	11	\$27.20
5890	GS-25-FBA	Aluminum	338	\$29.65
5891	GS-25-FBP	Acetal	18	\$29.65

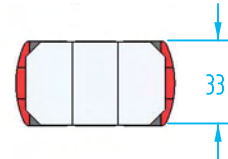
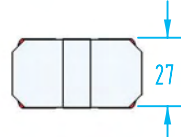
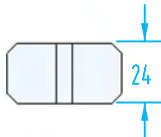
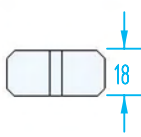

Dimensions with fingers open:

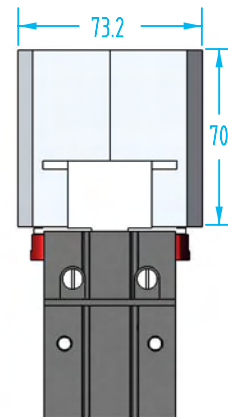
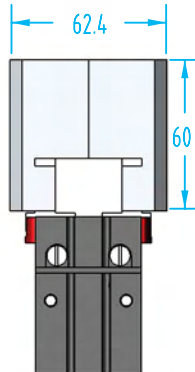
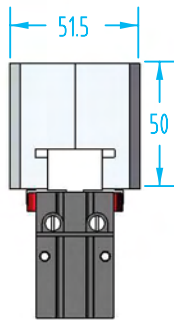
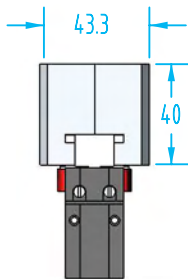

Dimensions with fingers closed:
(finger blanks are shown overlapped.
Cut away material to fit your part)

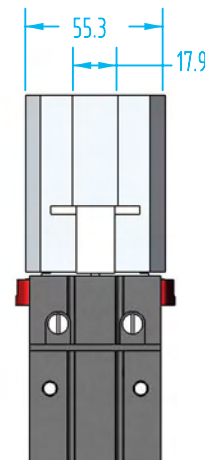
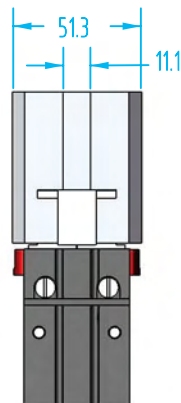
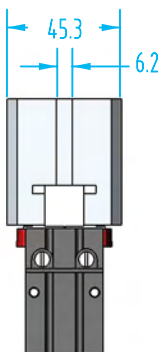
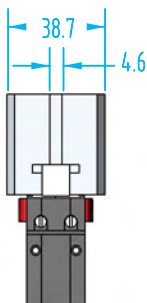

Finger Blanks for GW Grippers

(Dimensioned drawings shown full scale)

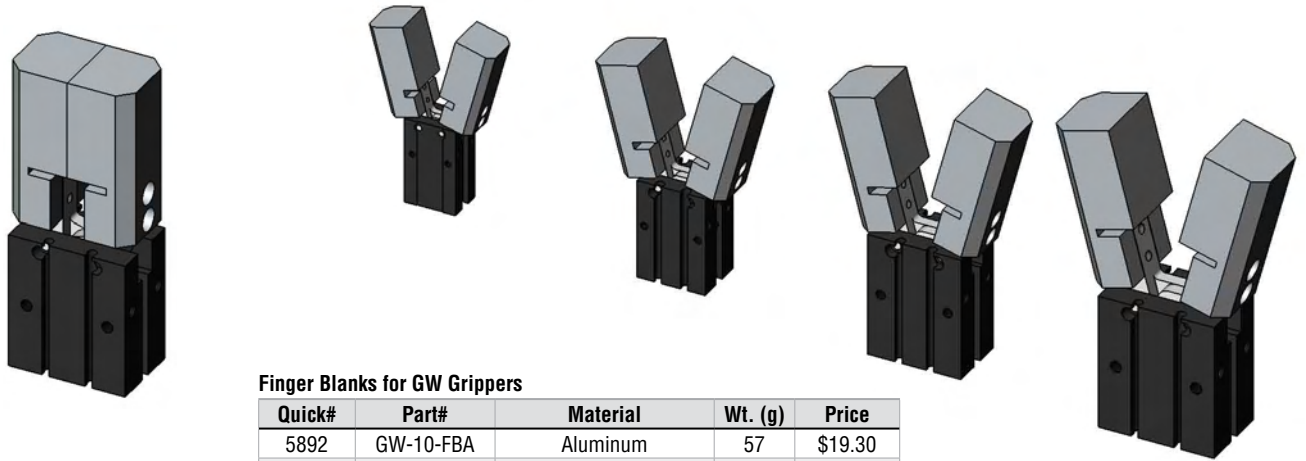

Finger Blanks for GW Grippers

Quick#	Part#	Material	Wt. (g)	Price
5892	GW-10-FBA	Aluminum	57	\$19.30
5893	GW-10-FBP	Acetal	3	\$19.30
5894	GW-16-FBA	Aluminum	117	\$23.85
5895	GW-16-FBP	Acetal	6	\$23.85
5896	GW-20-FBA	Aluminum	170	\$27.20
5897	GW-20-FBP	Acetal	9	\$27.20
5898	GW-25-FBA	Aluminum	268	\$29.65
5899	GW-25-FBP	Acetal	14	\$29.65

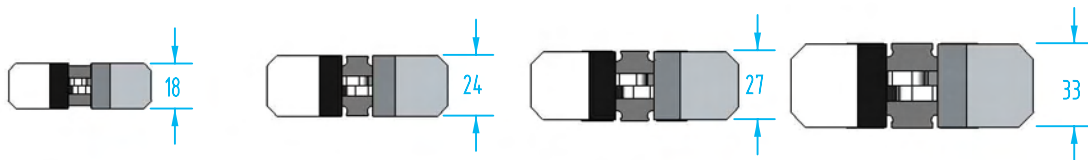

Dimensions with fingers open:

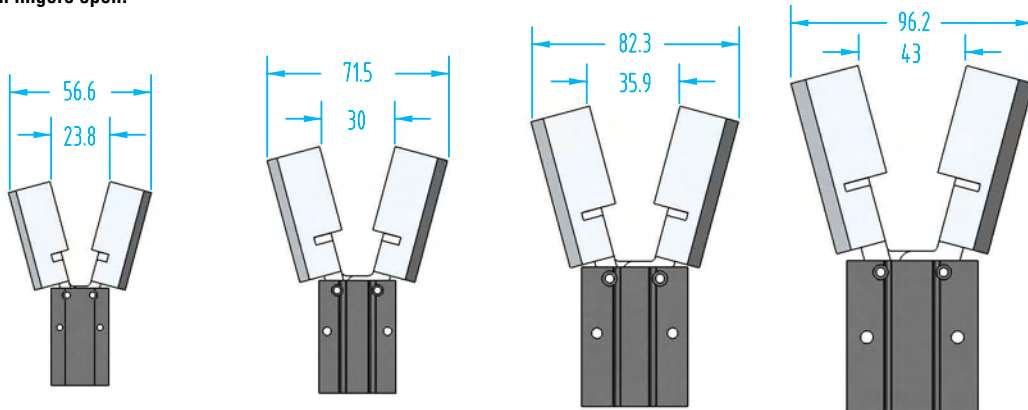

Dimensions with fingers closed:

